

# iTap 3

## Magnetic Flush Mount

User Manual

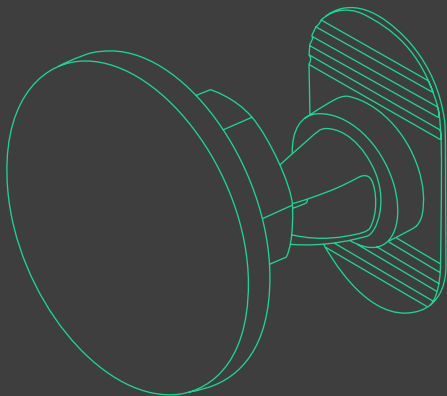

# iTap 3

## Magnetic Flush Mount

User Manual

	English .....	04
	French .....	14
	Italian .....	24
	German .....	34
	Spanish .....	44

# Index

For optimal mounting, please follow the detailed instructions within this manual when using the iTap 3 Magnetic Flush Mount. iOttie is not liable for possible damages due to product misuse.

## 01 Product Information

At a Glance

Device Compatibility

Product Specifications

## 02 Installation

Attaching the Mount

Attaching the Magnetic Ring Adapter

Mounting Your Phone

# 01 Product Information

## At a Glance

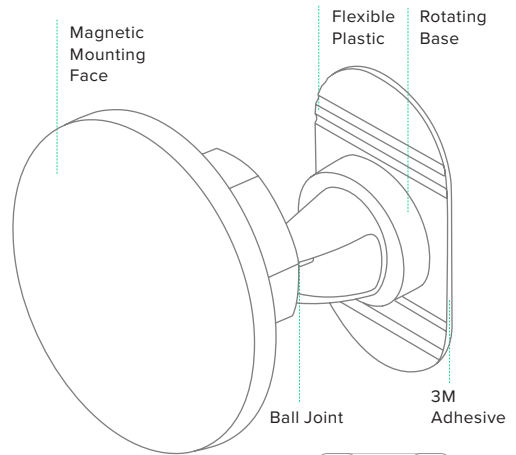

Magnetic Ring Adapter

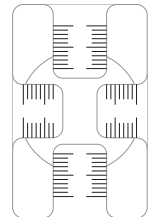

Alignment Guide



## Device Compatibility

iTap 3 products are compatible with MagSafe series iPhones and cases. The included magnetic adapter ring can be attached to the back of all other smartphones and smartphone cases for universal compatibility.



MagSafe Series  
iPhones and Cases

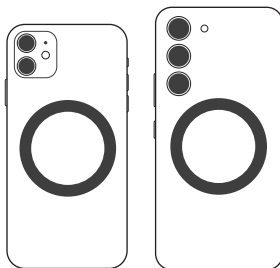

Non-MagSafe Phones  
and Cases via Magnetic  
Ring Adapter

## Product Specifications

Item	Specification
Length	2.56"
Width	2.7"
Height	2.28"
Weight	1.83 oz

## 02 Installation

### Attaching the Mount

1. Choose a mounting location and wipe the surface clean.

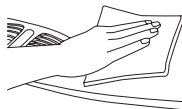

2. Connect the cradle to the flush mount and tighten the cradle knob.

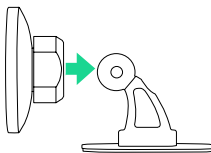

3. Peel off the film on the base of the flush mount.

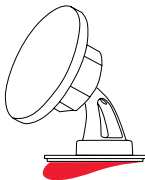

4. Press the flush mount evenly onto the mounting location for 30 seconds. Wait 20 minutes before mounting your phone.

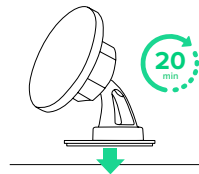

- The adhesive base features a semi-permanent tape. Once the mount is removed, it cannot be re-mounted.
- When mounting, it is recommended that the surface and product be above 65°F.
- When removing the flush mount, please use caution. We recommend removing slowly from the edge to avoid damage.

5. To change the viewing angle, loosen the cradle knob and adjust the mount to your desired position. Tighten to secure it in place.



## Attaching the Magnetic Ring Adapter

For devices and cases that are not Qi2 or MagSafe compatible, please attach the included magnetic ring adapter to the back of your phone or phone case to enable compatibility with the iTap 3.

**!** Not designed for use with metal, glass, or textured phone cases, or phones with built-in wallets or grips.

1. Clean the back of your phone or phone case with the wet wipe, then use the dry wipe.

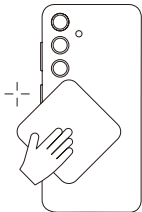

2. Position the alignment guide so that the opening is in the center of your phone or case.

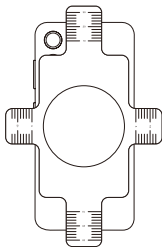

3. Remove the protective film from the magnetic ring.

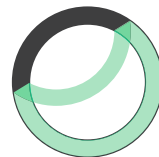

4. Carefully place the magnetic ring inside the opening on the alignment guide and press firmly. Wait at least one hour before using.

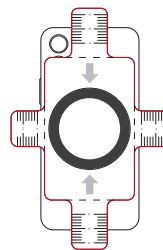

**!** Once attached, the ring can be removed, but not repositioned.

## Mounting Your Phone

Simply tap your phone against the mount and the magnets will hold it in place. You are now ready to start driving.

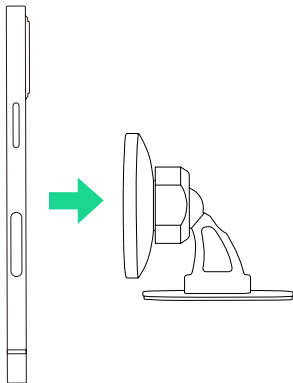

## Indice

Pour une installation optimale, veuillez suivre les instructions détaillées de ce manuel lorsque vous utilisez le support magnétique encastré iTap 3. iOttie n'est pas responsable des dommages éventuels causés par une mauvaise utilisation du produit.

### 01 Informations sur le produit

Aperçu

Compatibilité des appareils

Spécifications du produit

### 02 Installation

Fixation du support

Fixation de l'adaptateur d'anneau magnétique

Fixation de votre téléphone

## 01 Informations sur le produit

### Aperçu

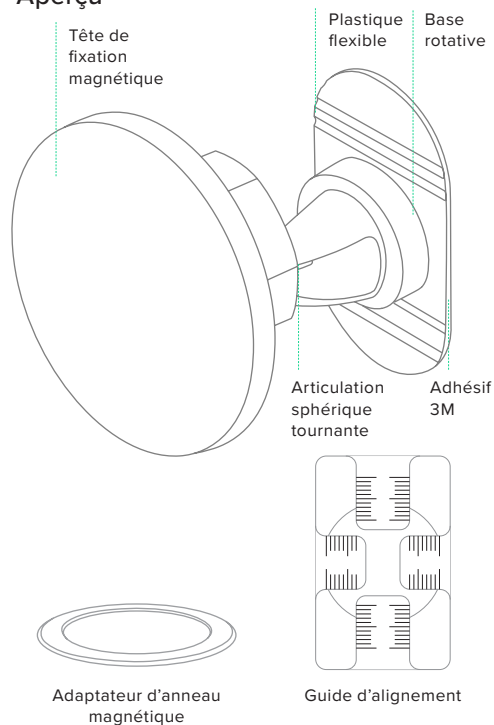



## Compatibilité des appareils

Les produits iTap 3 sont compatibles avec les iPhones et les étuis de la série MagSafe. La bague d'adaptation magnétique incluse peut être fixée à l'arrière de tout type de téléphone intelligent et étuis de téléphone pour une compatibilité universelle.



iPhones MagSafe de la série MagSafe et les étuis

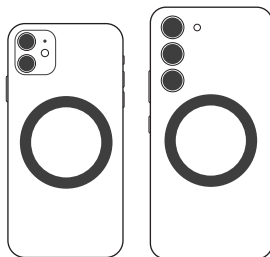

Téléphones cellulaires et étuis non-MagSafe avec l'anneau magnétique

## Spécifications du produit

Article	Spécifications
Longueur	6.5 cm
Largeur	6.9 cm
Hauteur	5.8 cm
Pois	52 g

## 02 Installation

### Fixation du support

1. Choisir un emplacement pour le montage puis essuyer la surface pour la rendre propre.

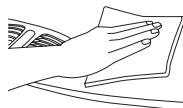

2. Connectez le berceau au support encastré et serrez le bouton du berceau.

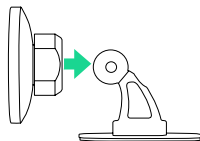

3. Décollez le film à la base du support encastré.

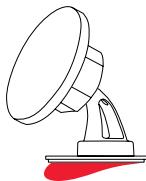

4. Appuyez fermement sur le support encastré sur l'emplacement d'installation souhaité pendant 30 secondes. Attendez 20 minutes avant de connecter votre téléphone.

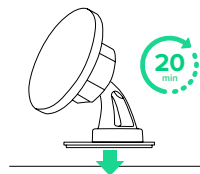

- Le coussin du tableau de bord est fixé d'un ruban adhésif semi-permanent. Une fois retiré, il ne peut pas être remonté.
- Lors du montage, il est recommandé que la surface et le produit soient au-dessus 20°C.
- Lors du retrait du coussin du tableau de bord, veuillez faire preuve de prudence. Nous vous recommandons de retirer lentement du bord de éviter tout dommage.

5. Pour faire pivoter le support, desserrez la vis de support. Serrez pour verrouiller dans la position désirée.



## Fixation de l'adaptateur d'anneau magnétique

Pour les appareils et les étuis qui ne sont pas compatibles avec Qi2 ou MagSafe, veuillez fixer l'adaptateur d'anneau magnétique inclus à l'arrière de votre téléphone ou de votre étui pour permettre la compatibilité avec l'iTap 3.

! N'est pas conçu pour être utilisé avec des étuis pour cellulaire en métal, en verre ou texturés, ou des étuis pour cellulaire avec portefeuilles ou poignées intégrées.

1. Nettoyez le dos de votre cellulaire ou de son étui avec la lingette humide, puis utilisez la lingette sèche.

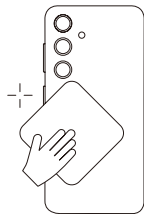

2. Positionnez le guide d'alignement de manière à ce que l'ouverture soit au centre de votre cellulaire ou de votre étui.

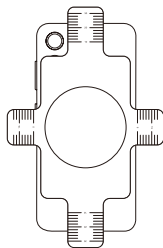

3. Retirez le film protecteur de l'anneau magnétique.

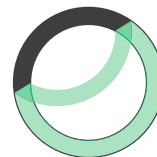

4. Placez soigneusement l'anneau magnétique à l'intérieur de l'ouverture du guide d'alignement et appuyez fermement. Attendez au moins une heure avant de l'utiliser.

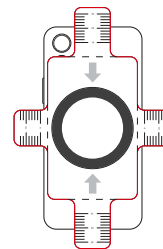

! Une fois fixé, l'anneau peut être retiré, mais pas repositionné.

## Fixation de votre téléphone

Il suffit de placer votre téléphone contre le support pour que les aimants le maintiennent en place. Vous êtes maintenant prêt à conduire.

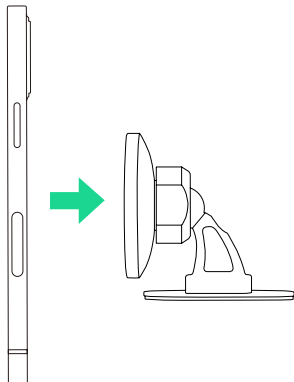

## Indice

Per una montatura ottimale, seguire le istruzioni dettagliate di questo manuale sulla Montatura Magnetica iTap 3. iOttie non é responsabile per eventuali danni causati da un uso improprio del prodotto.

### 01 Informazioni sul prodotto

A prima vista

Compatibilità del dispositivo

Specifiche del prodotto

### 02 Installazione

Fissare il supporto

Collegamento dell'adattatore per anello magnetico

Montaggio del telefono

## 01 Informazioni sul prodotto

### A prima vista

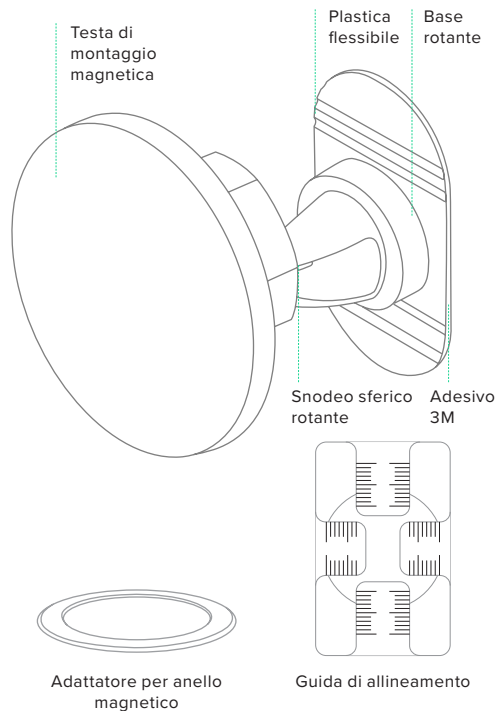

## Compatibilità del dispositivo

I prodotti iTap 3 sono compatibili con gli iPhone e le custodie della serie MagSafe. L'anello adattatore magnetico anello adattatore magnetico incluso è universalmente compatibile e può essere attaccato al retro di tutti gli altri smartphone e custodie per smartphone.



Serie MagSafe  
iPhones e custodie

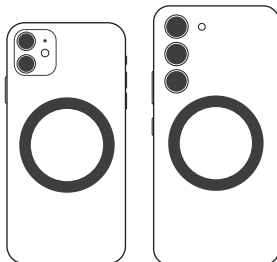

Telefoni e custodie  
non MagSafe tramite  
anello magnetico

## Specifiche del prodotto

Articolo	Caratteristiche
Lunghezza	6.5 cm
Larghezza	6.9 cm
Altezza	5.8 cm
Peso	52 g

## 02 Installazione

### Fissare il supporto

1. Scegliere dove posizionare la montatura, e pulire bene l'area.

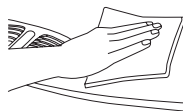

2. Collegare la base al supporto della montatura e serrare la manopola della base.

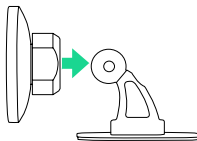

3. Rimuovere la pellicola alla base della montatura.

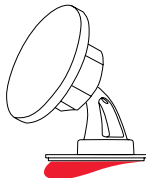

4. Premere fermamente sull'area dell'installazione per 30 secondi. Attendere 20 minuti prima di collegare il telefono.

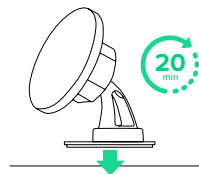

- Il cuscinetto del cruscotto è montato con adesivo semi-permanente. Una volta rimosso, non si può rimontare.
- Alla montatura, si consiglia di controllare che la superficie ed il prodotto siano sopra i 20°C.
- Si prega di fare attenzione quando si rimuove il cuscinetto del cruscotto. Si consiglia di rimuovere lentamente partendo dall'estremità per evitare danni.

5. Per ruotare la base, allentare la manopola della base. Serrare per bloccare nella posizione desiderata.



## Collegamento dell'adattatore per anello magnetico

Per consentire la compatibilità di iTap 3 con dispositivi e custodie non compatibili con Qi2 o MagSafe, ti invitiamo a collegare l'anello adattatore magnetico incluso nella confezione al retro del telefono o della custodia.

- ❗ Non progettato per l'utilizzo con custodie di metallo, vetro o sagomate, né con telefoni con portafogli o impugnature integrati.

1. Pulire il retro del telefono o della custodia con una salvietta umida, dopodiché usare una salvietta asciutta.

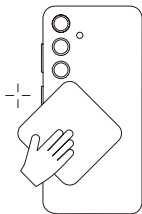

2. Posizionare la guida di allineamento in modo che l'apertura sia al centro del telefono o della custodia.

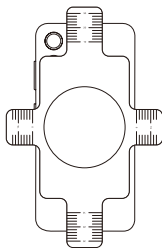

3. Rimuovere la pellicola protettiva dall'anello magnetico.

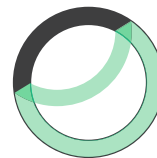

4. Posizionare con cura l'anello magnetico all'interno dell'apertura della guida di allineamento e premere a fondo. Attendere almeno un'ora prima dell'utilizzo.

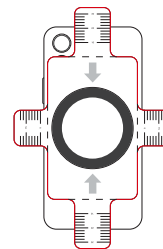

- ❗ Una volta fissato, l'anello può essere rimosso ma non riposizionato.



## Montaggio del telefono

Basta posizionare il telefono contro il supporto e i magneti lo terranno in posizione. Ora sei pronto per iniziare a guidare.

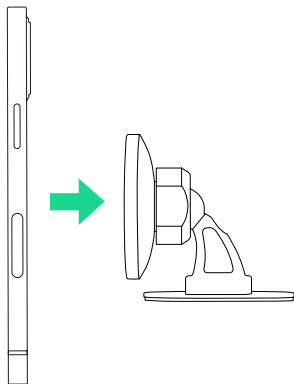

# Index

Für eine optimale Montage folgen Sie bei Verwendung der magnetischen iTap 3 Flachbefestigung bitte den detaillierten Anweisungen. iOttie haftet nicht fucht mögliche schäden, die auf grund einer unsachgemäßen verwendung des produkts entstehen.

## 01 Produktinformationen

Auf einen blick

Gerätekompatibilität

Produktspezifikationen

## 02 Installation

Anbringen der Halterung

Befestigung der Magnetringadapter

Einsetzen Ihres Telefons

# 01 Produktinformationen

## Auf einen blick

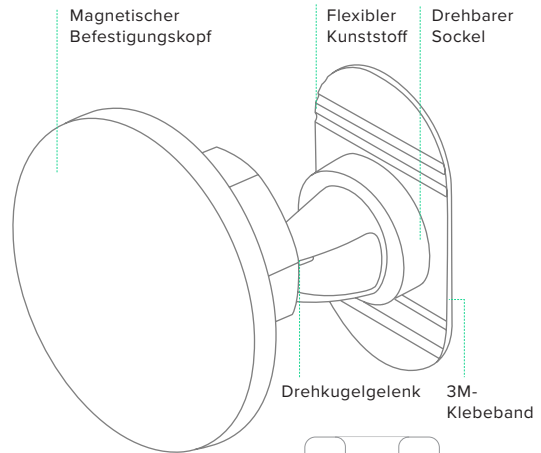

Magnetringadapter

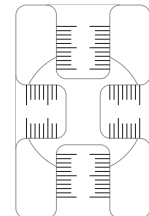

Schablone



## Gerätekompatibilität

Die iTap 3 Produkte sind mit iPhones und Hüllen der MagSafe-Serie kompatibel. Der mitgelieferte magnetische Adapterring kann auf der Rückseite aller Smartphones und Hüllen angebracht werden, für eine universelle Kompatibilität.



iPhones und Hüllen  
der MagSafe-Serie

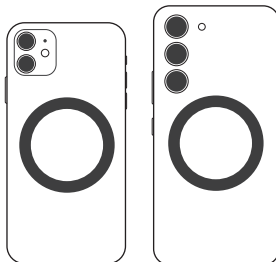

Telefone & Hüllen  
ohne MagSafe mit  
Magnetring

## Produktspezifikationen

Artikel	Spezifikationen
Länge	6.5 cm
Breite	6.9 cm
Höhe	5.8 cm
Gewicht	52 g

## 02 Installation

### Anbringen der Halterung

1. Wählen Sie einen Befestigungsort und wischen Sie die Oberfläche sauber.

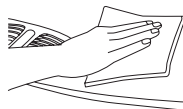

2. Verbinden Sie die Halterung mit der Flachbefestigung und ziehen Sie den Halterungsknopf an.

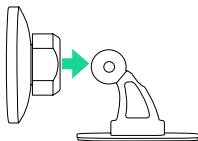

3. Ziehen Sie die Folie an der Unterseite der Flachbefestigung.

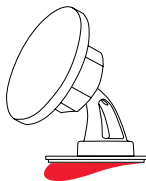

4. Drücken Sie die Flachbefestigung 30 Sekunden lang fest auf den gewünschten Einbaort. Warten Sie 20 Minuten, bevor Sie Ihr Telefon anbringen.

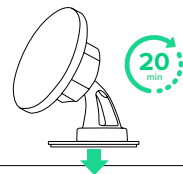

- Das Armaturenbrett-Pad wird mit einem semipermanenten Klebeband befestigt.
- Bei der Montage wird empfohlen, dass die Oberfläche und das Produkt eine Temperatur von über 20°C haben.
- Gehen Sie beim Entfernen des Armaturenbrett-Pads bitte vorsichtig vor. Wir empfehlen, das Pad langsam von der Ecke aus zu entfernen, um Schäden zu vermeiden.

5. Um die Wiege zu drehen, lösen Sie den Wiesenknopf. Anziehen, um in der gewünschten Position zu arretieren.

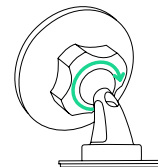

## Befestigung der Magnetringadapte

Bringen Sie bei Geräten und Hüllen, die nicht mit Qi2 oder MagSafe kompatibel sind, den mitgelieferten magnetischen Adapterring an der Rückseite Ihres Telefons oder der Hülle an, für die Kompatibilität mit dem iTap 3.

! Nicht geeignet für Handyhüllen aus Metall, Glas oder mit Textur, eingebauten Fächern oder Griffen.

1. Säubern Sie die Rückseite Ihres Telefons oder der Hülle mit dem feuchten Tuch und dann mit dem trockenen Tuch.

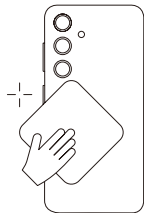

2. Richten Sie die Schablone so aus, dass sich die Öffnung in der Mitte Ihres Telefons oder der Hülle befindet.

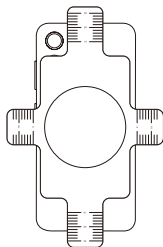

3. Entfernen Sie die Schutzfolie vom Magnetring.

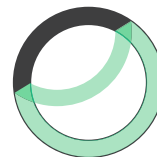

4. Setzen Sie den Magnetring vorsichtig in die Öffnung der Schablone und drücken Sie ihn fest. Warten Sie vor dem Gebrauch mindestens eine Stunde.

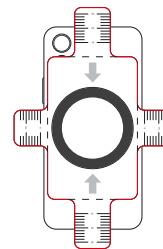

! Wenn Sie den Ring angebracht haben, können Sie ihn entfernen, aber nicht neu ausrichten.

## Einsetzen Ihres Telefons

Platzieren Sie Ihr Telefon einfach an der Halterung und die Magnete sorgen dafür, dass es an Ort und Stelle bleibt. Jetzt können Sie losfahren.

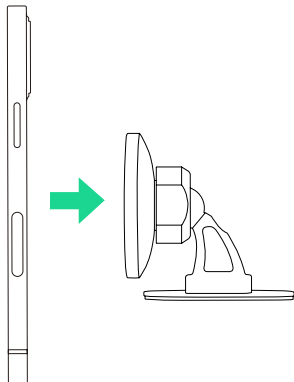

# Índice

Para un montaje óptimo, siga las instrucciones detalladas en este manual al usar la Montura Empotrada Magnética de iTap 3. iOttie no es responsable por posibles daños debidos al uso incorrecto del producto.

## 01 Información del producto

De un vistazo

Compatibilidad de dispositivos

Especificaciones del producto

## 02 Instalación

Colocación del soporte

Colocación del adaptador de anillo magnético

Montaje del teléfono

## 01 Información del producto

De un vistazo

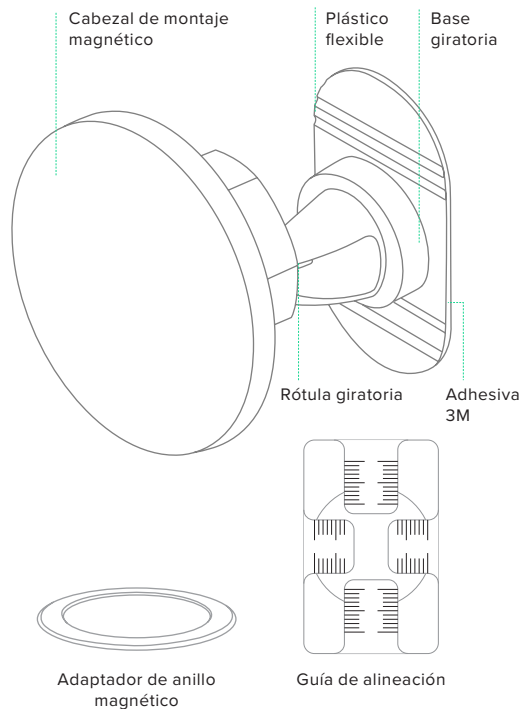

## Compatibilidad de dispositivos

Los productos iTap 3 son compatibles con iPhones y fundas serie MagSafe. El anillo adaptador magnético incluido se puede colocar en la parte posterior de todos los demás teléfonos inteligentes y fundas para teléfonos inteligentes para una compatibilidad universal.



iPhones y fundas de la serie MagSafe

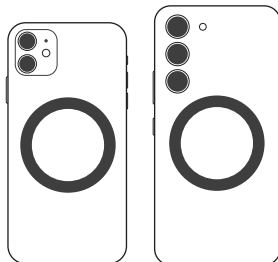

Teléfonos y fundas que no son MagSafe mediante anillo magnético

## Especificaciones del producto

Artículo	Especificación
Longitud	6.5 cm
Ancho	6.9 cm
Altura	5.8 cm
Peso	52 g



## 02 Instalación

### Colocación del soporte

1. Elija un espacio de montaje y limpie la superficie.

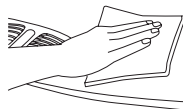

2. Conecte la base al soporte de la montura empotrada y apriete la perilla de la base.

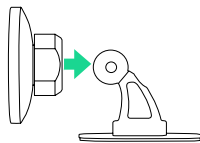

3. Retire la película de la base de la montura empotrada.

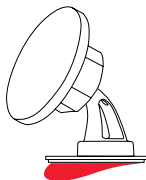

4. Presione firmemente la montura empotrada sobre el lugar deseado para su instalación durante 30 segundos. Espere 20 minutos antes de conectar su teléfono.

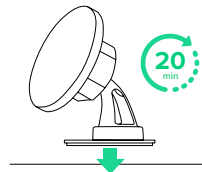

- La almohadilla del tablero está montada con una cinta adhesiva semipermanente. Una vez que es retirada, no puede montarse otra vez.
- Al hacer el montaje, se recomienda que la superficie y el producto tengan una temperatura superior a los 20°C.
- Tenga cuidado al retirar la almohadilla del tablero. Recomendamos retirarla lentamente desde el borde para evitar dañarla.

5. Para girar la horquilla, afloja la perilla de la horquilla. Apriete para bloquear en la posición deseada.



## Colocación del adaptador de anillo magnético

Para dispositivos y fundas que no son compatibles con Qi2 o MagSafe, conecte el adaptador de anillo magnético incluido a la parte posterior de su teléfono o funda para habilitar la compatibilidad con iTap 3.

**!** No está diseñado para usarse con fundas de teléfono de metal, vidrio o texturizadas, ni con teléfonos con billeteras o asas integradas.

1. Limpie la parte posterior del teléfono o la funda del teléfono con el paño húmedo; luego use el paño seco.

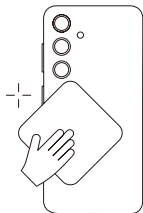

2. Coloque la guía de alineación de modo que la abertura esté en el centro del teléfono o la funda.

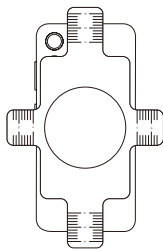

3. Retire la película protectora del anillo magnético.

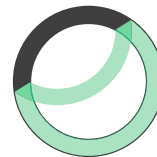

4. Coloque cuidadosamente el anillo magnético dentro de la abertura en la guía de alineación y presione firmemente. Espere al menos una hora antes de usar.

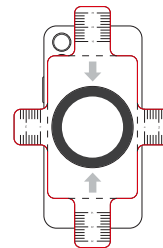

**!** Una vez colocado, el anillo se puede quitar, pero no se puede volver a colocar.

## Montaje del teléfono

Simplemente coloque su teléfono contra el soporte, y los imanes lo mantendrán en su lugar. Ahora está listo para empezar a conducir.

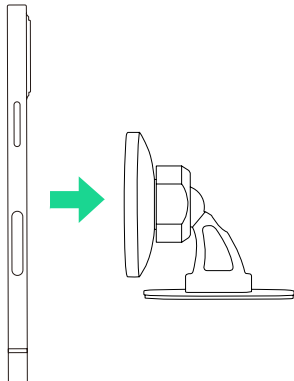



The iTap 3 Flush Mount is backed by  
a 2 year warranty.

**iottie**