

Velox™

Mini Qi2 Wireless
Air Vent Mount

User Manual

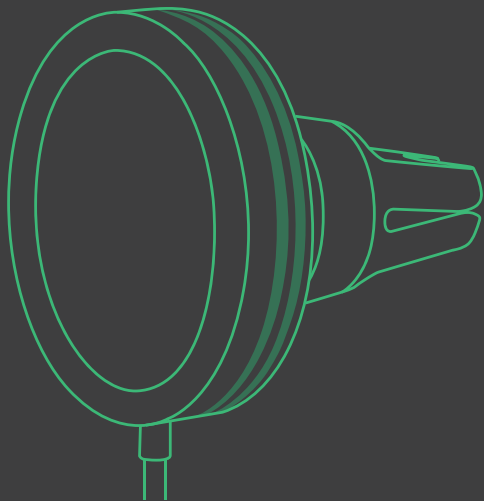



Mini Qi2 Wireless Charger Air Vent Mount

User Manual

	English	04
	French	10
	Italian	16
	German	22
	Spanish	28

Index

For optimal mounting and charging, please follow the detailed instructions within this manual when using the Velox Mini Qi2 Wireless Air Vent Mount.

01 Product Information

At a Glance

- 01 Product Information**
 - At a Glance
 - Device Compatibility
 - Product Specifications

- 02 Installation**
 - Attaching the Mount
 - Connecting to Power
 - Mounting Your Phone

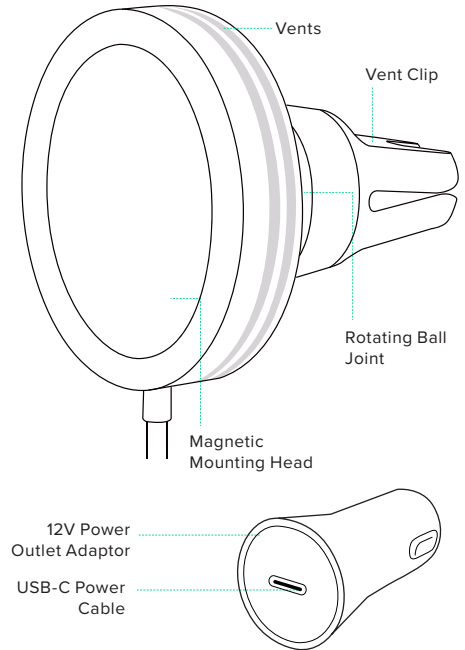

Device Compatibility

Designed for use with Qi2-enabled smartphones including MagSafe iPhone series 13 and later.

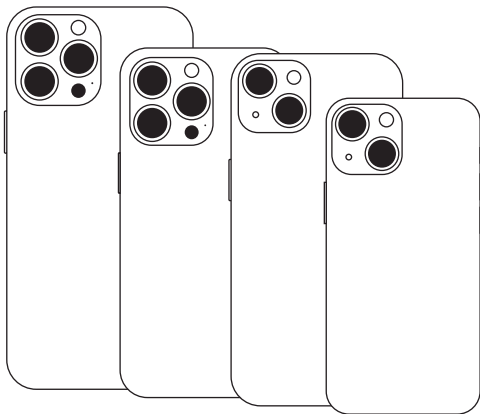

Product Specifications

Item	Specification
Total Input	DC 5V/3A DC 9V-2.22A DC 12V-1.67A
Wireless Charger Output	5W/7.5W/15W
Cable Length	5'
Mount Length	2.35"
Mount Width	2.31"
Mount Height	2.31"
Mount Weight	3.22 oz.

Power Adapter Specifications

Input	Output
DC 12V ~ 24V	DC 5V ~ 3A DC 9V ~ 2A DC 12V ~ 1.5A

*iOttie is not liable for possible damages due to product misuse.

02 Installation

Attaching the Mount

Push the Velox Mini Qi2 onto the blade of your vehicle's air vent. The silicon texture of the prongs will ensure that the mount does not fall off even when driving on rough roads.

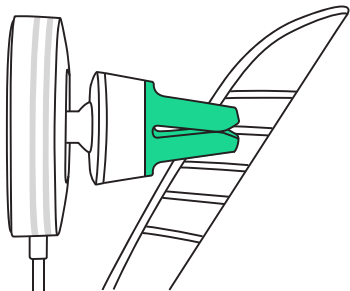

*Mount is designed to be used only with FLAT air vent blades.

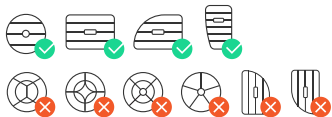

Connecting to Power

Connect the USB-C cable to your vehicle's USB-C port or auxiliary power outlet via the included 20W adapter.

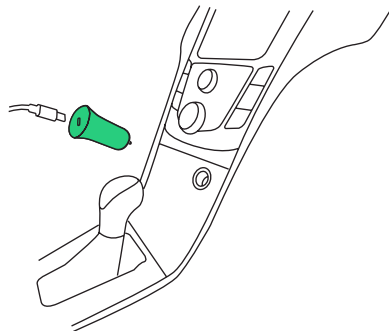

*The Velox Mini Qi2 does not have an On/Off switch. Once the cable is plugged in and the vehicle is turned on, the mount will stay on.

Mounting Your Phone

Tap your phone against the mount and the magnets will hold it in place. Charging will start automatically. You are now ready to start driving.

Indice

Pour une fixation et une recharge optimales, veuillez suivre les instructions détaillées dans ce manuel lorsque vous utilisez le Velox Mini Qi2.

01 Informations sur le produit

Aperçu

Compatibilité des appareils

Spécifications du produit

02 Installation

Fixation du support

Connexion à l'alimentation

Fixation de votre téléphone

01 Informations sur le produit

Aperçu

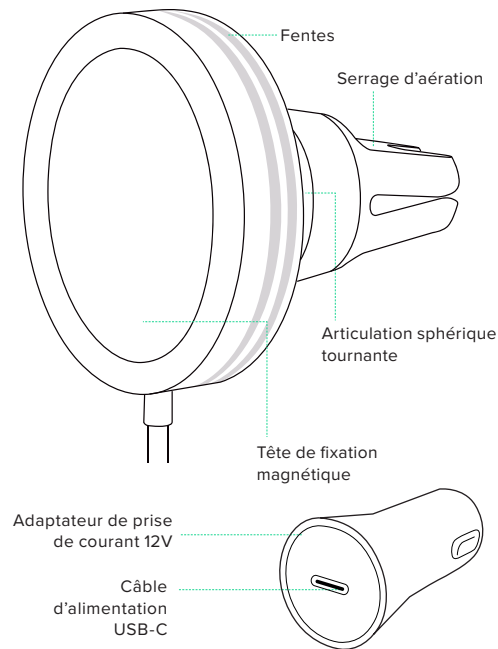

Compatibilité des appareils

Compatible avec les smartphones compatibles Qi2 et les iPhones de la série MagSafe, y compris la série iPhone 13 et versions ultérieures.

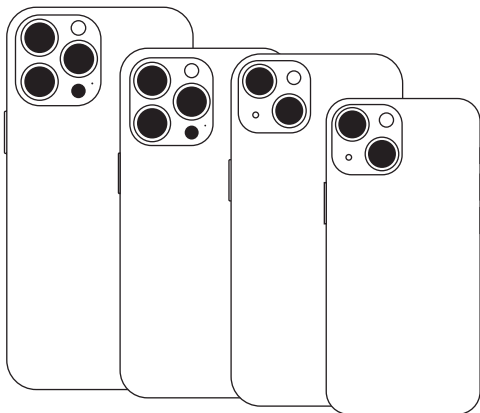

Spécifications du produit

Article	Spécifications
Entrée totale	DC 5V/3A DC 9V-2.22A DC 12V-1.67A
Sortie chargeur sans fil	5W/7.5W/15W
Longueur de câble	1.52 m
Longueur de montage	5.98 cm
Largeur de montage	5.87 cm
Hauteur de montage	5.87 cm
Poids de montage	91.5 g

Spécifications du Chargeur de Voiture

Entrée	Sortie
DC 12V ~ 24V	DC 5V ~ 3A DC 9V ~ 2A DC 12V ~ 1.5A

*iOttie n'est pas responsable des dommages éventuels causés par une mauvaise utilisation du produit.

02 Installation

Fixation du support

Il suffit de pousser le support Velox Qi2 sur la lame de la grille d'aération de votre véhicule. La texture siliconée des griffes permet d'éviter que le support ne tombe, même sur des routes difficiles.

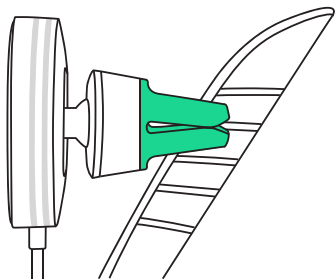

*Le support est conçu pour être utilisé uniquement avec des lames de grilles d'aération plates.



Connexion à l'alimentation

Connectez le câble USB-C au port USB-C ou au port auxiliaire de votre véhicule via l'adaptateur 20 W inclus.

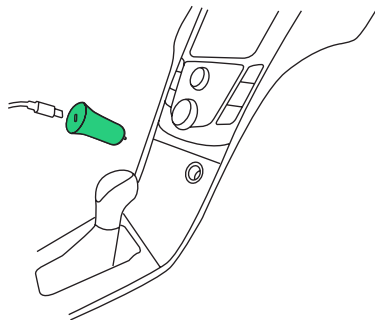

*Le support de chargeur sans fil magnétique Velox Qi2 n'a pas d'interrupteur marche/arrêt. Une fois le câble branché et le véhicule allumé, le support reste en place.

Fixation de votre téléphone

Il suffit de placer votre téléphone contre le support pour que les aimants le maintiennent en place et que la charge se déclenche automatiquement. Vous êtes maintenant prêt à conduire.

Indice

Per un montaggio e ricarica ottimali, seguire le istruzioni dettagliate contenute in questo manuale per usare usare il Velox Mini Qi2.

01 Informazioni sul prodotto

A Prima vista

Compatibilità del dispositivo

Specifiche del prodotto

02 Installazione

Collegare il supporto

Collegamento all'alimentazione

Montaggio del telefono



01 Informazioni sul prodotto

A Prima vista

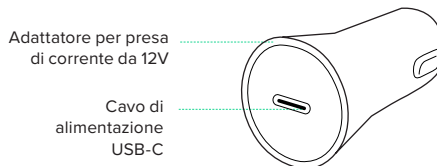
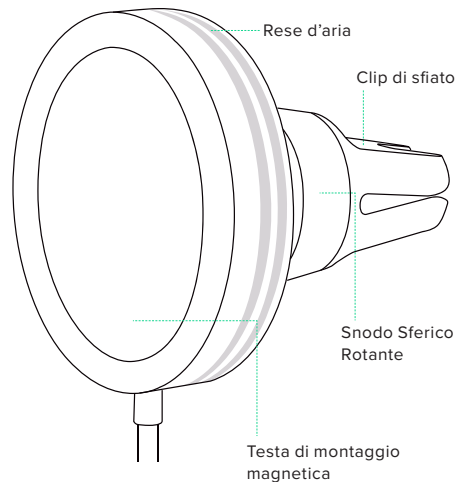

Compatibilità del dispositivo

Compatibile con smartphone abilitati Qi2 e iPhone della serie MagSafe, inclusi iPhone serie 13 e versioni successive.

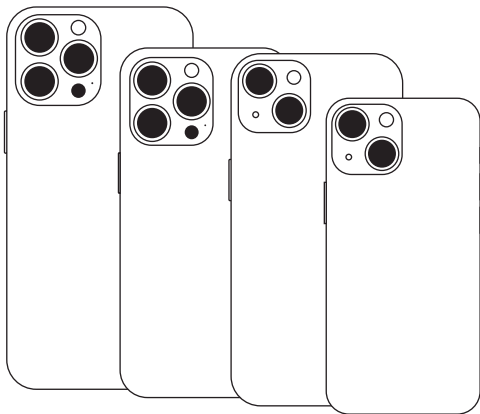

Specifiche del prodotto

Specifiche del prodotto	Caratteristiche
Ingresso	DC 5V/3A DC 9V-2.22A DC 12V-1.67A
Uscita cariche wireless	5W/7.5W/15W
Lunghezza del cavo	1.52 m
Larghezza di montaggio	5.98 cm
Larghezza di montaggio	5.87 cm
Altezza di montaggio	5.87 cm
Peso	91.5 g

Specifiche dell'adattatore

Ingresso	Uscita
DC 12V ~ 24V	DC 5V ~ 3A DC 9V ~ 2A DC 12V ~ 1.5A

*iOttie non è responsabile per eventuali danni causati da un uso improprio del prodotto.

02 Installazione

Collegare il supporto

Basta spingere il supporto Velox Qi2 sulla lama della presa d'aria del vostro veicolo. La struttura in silicone dei rebbi assicura che il supporto non cada anche quando si guida su strade accidentate.

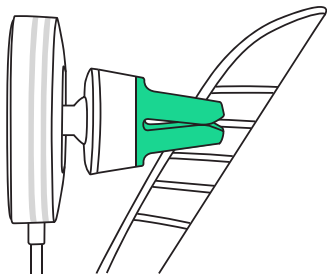

*Il supporto è progettato per essere usato solo con le pale di ventilazione FLAT.



Collegamento all'alimentazione

Collega il cavo USB-C alla porta USB-C del tuo veicolo o alla porta ausiliaria tramite l'adattatore da 20 W inclus.

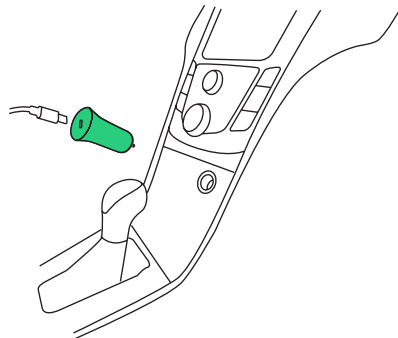

*Il Velox Qi2 non ha un interruttore acceso/spento. Una volta che il cavo è collegato e il veicolo è acceso, il supporto rimarrà acceso.

Montaggio del telefono

Basta posizionare il telefono contro il supporto e i magneti lo terranno in posizione, la ricarica inizierà automaticamente. Ora sei pronto per iniziare a guidare.

Index

Um eine optimale Befestigung und Aufladung zu gewährleisten, befolgen Sie bitte die detaillierten Anweisungen in diesem Handbuch, wenn Sie der Velox Mini Qi2.

01 Produktinformationen

Auf einen Blick

Gerätekompatibilität

Produktspezifikationen

02 Installation

Befestigung der Halterung

Anschließen der Stromversorgung

Befestigung Ihres Telefons

01 Produktinformationen

Auf einen Blick

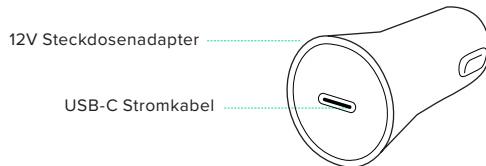
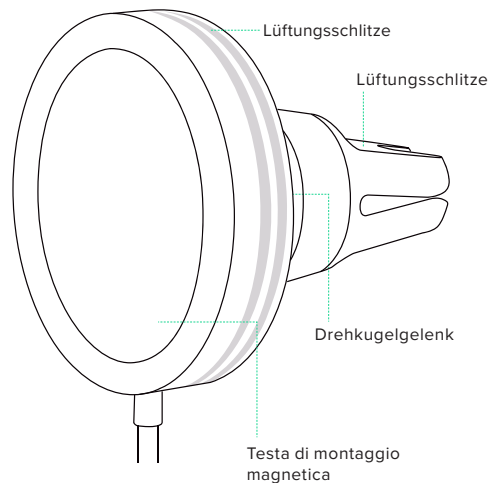

Gerätekompatibilität

Kompatibel mit Qi2-fähigen Smartphones und iPhones der MagSafe-Serie, einschließlich iPhone 13-Serie und höher.

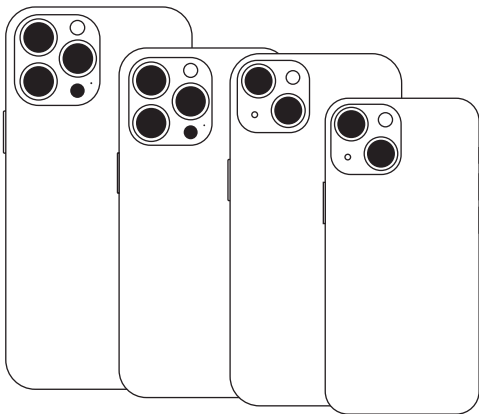

Produktspezifikationen

Artikel	Spezifikationen
Gesamteingabe	DC 5V/3A DC 9V-2.22A DC 12V-1.67A
Ausgang für kabelloses Ladegerät	5W/7.5W/15W
Kabellänge	1.52 m
Montagelänge	5.98 cm
Montagebreite	5.87 cm
Montagehöhe	5.87 cm
Montagegewicht	91.5 g

Spezifikationen des Netzteils

Eingang	Ausgabe
DC 12V ~ 24V	DC 5V ~ 3A DC 9V ~ 2A DC 12V ~ 1.5A

*iOttie haftet nicht für mögliche Schäden, die auf Grund einer unsachgemäßen Verwendung des Produkts entstehen.

02 Installation

Befestigung der Halterung

Drücken Sie die Velox Qi2-Halterung einfach auf das Gitter der Lüftung Ihres Fahrzeugs. Die Silikonbeschichtung der Zinken sorgt dafür, dass die Halterung auch bei Fahrten auf unebnen Straßen nicht herunterfällt.

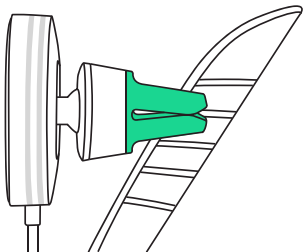

*Die Halterung ist ausschließlich für die Verwendung an FLACHEN Lüftungslamellen vorgesehen.



Anschließen der Stromversorgung

Schließen Sie das USB-C-Kabel über den mitgelieferten 20W-Adapter an den USB-C-Anschluss Ihres Fahrzeugs oder an den Zusatzanschluss an.

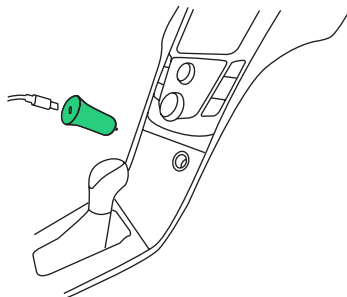

*Der Velox Qi2 verfügt nicht über einen ein-/Ausschalter. Sobald das Gerät an die Stromquelle angeschlossen ist, bleibt es eingeschaltet.

Befestigung Ihres Telefons

Platzieren Sie Ihr Telefon einfach an der Halterung und die Magnete sorgen dafür, dass es an Ort und Stelle bleibt. Der Ladevorgang beginnt automatisch. Jetzt können Sie losfahren.

Índice

Para un montaje y carga óptimos, siga las instrucciones detalladas en este manual cuando utilice el Velox Mini Qi2.

01 Información del producto

De un vistazo

Compatibilidad de dispositivos

Especificaciones del producto

02 Instalación

Colocación del soporte

Conexión a la corriente

Montaje del teléfono

01 Información del producto

De un vistazo

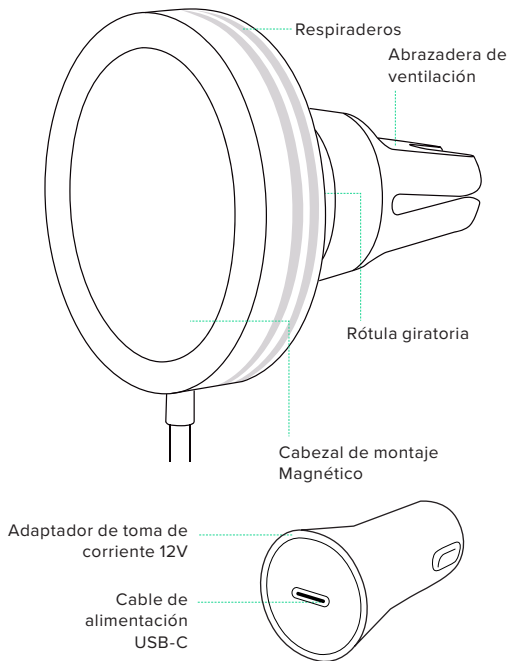

Compatibilidad de Dispositivos

Compatible con teléfonos inteligentes habilitados para Qi2 y iPhones de la serie MagSafe, incluida la serie iPhone 13 y posteriores.

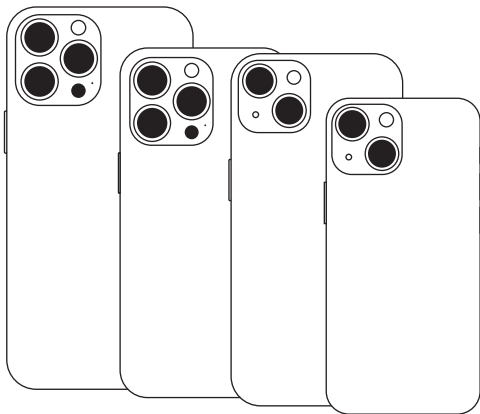

Especificaciones del producto

Artículo	Especificación
Entrada Total	DC 5V/3A DC 9V-2.22A DC 12V-1.67A
Salida de cargador inalámbrico	5W/7.5W/15W
Longitud del cable	1.52 m
Longitud de montaje	5.98 cm
Ancho de montaje	5.87 cm
Altura de montaje	5.87 cm
Peso de montaje	91.5 g

Información de Seguridad

Alimentación	Salida
DC 12V ~ 24V	DC 5V ~ 3A DC 9V ~ 2A DC 12V ~ 1.5A

*iOttie no es responsable por posibles daños debidos al uso incorrecto del producto.

02 Instalación

Colocación del soporte

Simplemente coloque el soporte Velox Qi2 en la rejilla de ventilación de su vehículo. La textura de las púas asegurará que el soporte no se caiga incluso cuando se conduce en caminos en mal estado.

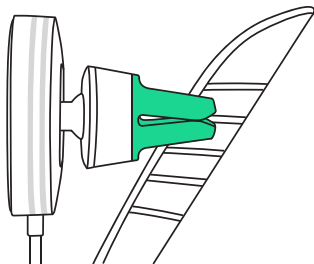

*El soporte está diseñado para usarse solo con rejillas de ventilación PLANAS.



Conexión a la corriente

Conecte el cable USB-C al puerto USB-C de su vehículo o al puerto auxiliar mediante el adaptador de 20W incluido.

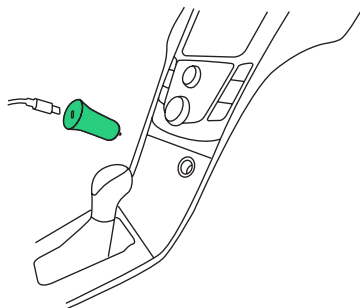

*El Velox Qi2 no tiene un interruptor de encendido/apagado. Una vez que el cable está enchufado y el vehículo está encendido, el soporte permanecerá encendido.

Montaje del teléfono

Simplemente coloque su teléfono contra el soporte, y los imanes lo mantendrán en su lugar y la carga comenzará automáticamente. Ahora está listo para empezar a conducir.

Operation Warnings

This device complies with part 15 of the FCC rules. Operation is subject to the following two conditions: (1) this device may not cause harmful interference, and (2) this device must accept any interference received, including interference that may cause undesired operation.

NOTE: The manufacturer is not responsible for any radio or TV interference caused by unauthorized modifications to this equipment. Such modifications could void the user's authority to operate the equipment.

NOTE: This equipment has been tested and found to comply with the limits for a Class B digital device, pursuant to part 15 of the FCC Rules. These limits are designed to provide reasonable protection against harmful interference in a residential installation. This equipment generates uses and can radiate radio frequency energy and, if not installed and used in accordance with the instructions, may cause harmful interference to radio communications. However, there is no guarantee that interference will not occur in a particular installation. If this equipment does cause harmful interference to radio or television reception, which can be determined by turning the equipment off and on, the user is encouraged to try to correct the interference by one or more of the following measures:

- Reorient or relocate the receiving antenna.
- Increase the separation between the equipment and receiver.
- Connect the equipment into an outlet on a circuit different from that to which the receiver is connected.
- Consult the dealer or an experienced radio/TV technician for help.

- This device and its antenna(s) must not be co-located or operating in conjunction with any other antenna or transmitter.

This equipment complies with FCC radiation exposure limits set forth for an uncontrolled environment. This equipment should be installed and operated with minimum distance of 20 cm between the radiator and your body. This transmitter must not be co-located or operating in conjunction with any other antenna or transmitter.

Operating temperature: -10-55°C

Operating frequency range: 2402-2480MHz

Rated Power: For Classic: 9.1dBm, BLE: 8.1dBm

Declaration of Conformity: Hereby, iOttie, Inc. declares that the radio equipment type Velox™ Magnetic Wireless Charger Mini Air Vent Mount is in compliance with Directive 2014/53/EU.

The full text of the EU declaration of conformity is available at the following internet address: www.iottie.com

This device may be used in each EU member state.

Important Safety Information

This manual contains important safety and operating instructions for the Velox™ Magnetic Wireless Charger Mini Air Vent Mount.

Please read all instructions and safety information before using this product. If damage occurs as a result of failure to follow the instructions, the warranty will be voided.

- Do not expose to rain, moisture, or snow.
- Using an attachment made or sold by anyone other than the manufacturer is not recommended, doing so may result in an increased risk of fire, electric shock, or injury.
- Do not operate this magnetic wireless charging mount if it has received a sharp blow, been dropped, or otherwise damaged in any way; take it to a qualified service person.
- Do not disassemble this magnetic wireless charging mount; take it to a qualified service person when service or repair is required. Incorrect reassembly may result in electric shock or fire.
- To reduce the risk of electric shock, unplug this car charger before attempting any maintenance or cleaning. Turning off the vehicle controls will not reduce this risk.
- Avoid extended exposure to direct sunlight, which may damage the device.
- Exposing this product to open flames may cause it to explode.
- Do not expose this product to strong magnetic fields.
- Use a dry, soft lint-free cloth to clean. Do not use any corrosive cleaner or oil to clean.

*Always obey traffic laws and pay attention to the road. Do not attempt to use this device while driving.



This product complies with the radio interference requirements of the European Community.



This product is designed and manufactured with high quality materials and components, which can be recycled and reused.



This symbol means the product must not be discarded as household waste, and should be delivered to an appropriate collection facility for recycling. Proper disposal and recycling helps protect natural resources, human health and the environment. For more information on disposal and recycling of this product, contact your local municipality, disposal service, or the shop you bought this product.

Designed in New York City. 470 7th Ave., New York, NY 10018.
Made in China. U.S. Patent Pending ©2023 iOttie. All rights reserved. iOttie and Velox are registered trademarks owned by iOttie, Inc. John 3:16

Apple, the Apple logo, iPhone, iPod, iPod touch, Mac, macOS, Magsafe and Siri are trademarks of Apple Inc., registered in the U.S. and other countries.



The Velox Mini Wireless Air Vent Mount
is backed by a 2 year warranty.

iottie

MagSafe Compatible

Only compatible with MagSafe
iPhone series and cases.