

Velox™

Magnetic Wireless Charging Dash & Windshield Mount

User Manual

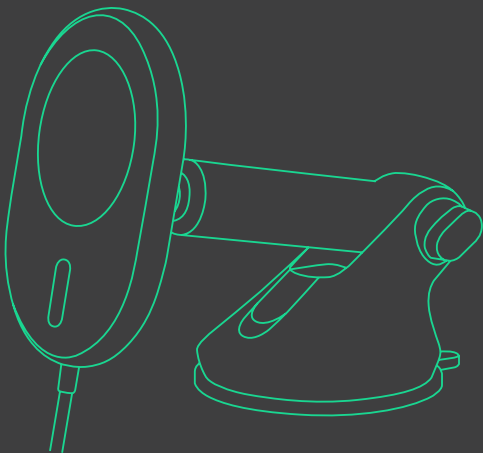

Velox™

Magnetic Wireless Charging Dash & Windshield Mount

User Manual

	English	04
	French	12
	Italian	20
	German	28
	Spanish	36

Index

For optimal mounting and charging, please follow the detailed instructions within this manual when using the Velox Magnetic Wireless Charging Dash & Windshield Mount.

01 Product Information

At a Glance

Device Compatibility

Product Specifications

02 Installing the Velox Dash Mount

Attaching the Dash Mount

Connecting to Power

Mounting Your iPhone

01 Product Information

At a Glance

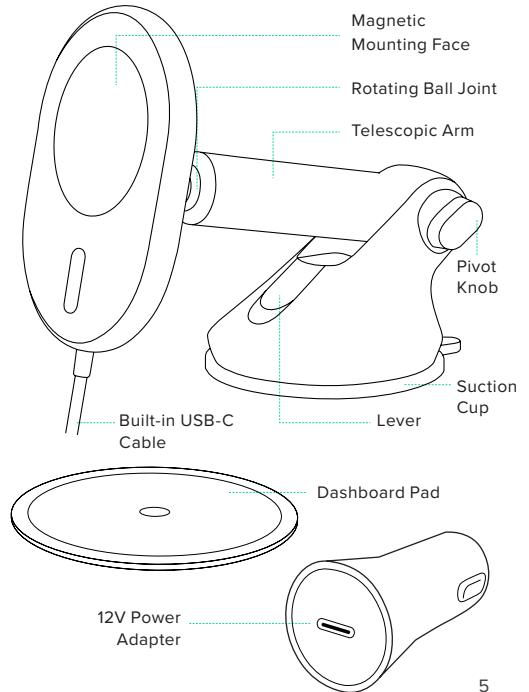

Device Compatibility

Velox products are designed for use with MagSafe compatible iPhones and cases.

Compatible devices include the iPhone 13, iPhone 13 mini, iPhone 13 Pro, iPhone 13 Pro Max, and the iPhone 12 series.

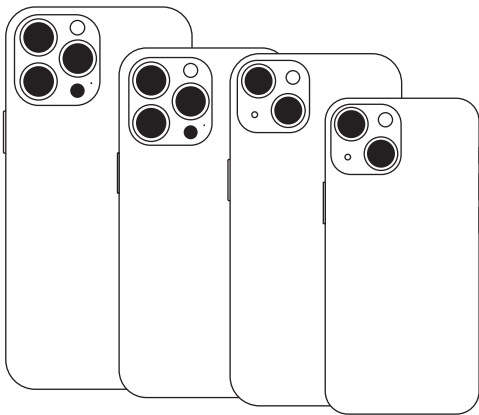

iPhone 13 Pro Max & 13 Pro

iPhone 13 & 13 Mini

Product Specifications

Item	Specification
Total Input	DC 9.0V-1.67A DC 5.0V-2.0A
Wireless Charger Output	7.5 W
Cable Length	5'
Mount Length	3.58"
Width	2.6"
Height	4.7"
Weight	8.05 oz

Power Adapter Specifications

Input	Output
DC 12V ~ 24V	DC 5V ~ 3A DC 9V ~ 2A DC 12V ~ 1.5A

*iOttie is not liable for possible damages due to product misuse.

02 Installing the Velox Dash Mount

Attaching the Dash Mount

Choose an installation method: dashboard/flat surface (A) or windshield (B).

Option A

Dashboard or Flat Surface Installation

Choose a flat area on the vehicle's dashboard and wipe any dust or debris from the surface.

**If your vehicle has a leather dashboard we recommend windshield mounting to avoid damaging your dash.*

1. Peel off the film on the dashboard pad & attach to the desired installation location.

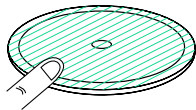

2. Peel off the protective film on the suction cup and press firmly onto the dashboard pad.

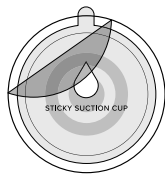

3. Push down the locking lever to engage suction.

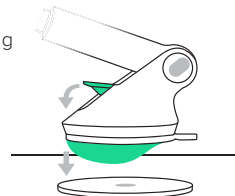

- The dashboard pad is mounted with a semi-permanent adhesive tape. Once removed, it cannot be re-mounted.
- When mounting, it is recommended that the surface and product be above 40°F.
- When removing the dashboard pad, please use caution. We recommend removing slowly from the edge to avoid damage.

Option B Windshield Installation

Choose a location on the windshield and wipe any dust or debris from the surface.

*The dashboard pad is not recommended for windshield mounting.

1. Peel off the protective film on the suction cup and press firmly onto the windshield.



2. Push down the locking lever to engage suction.

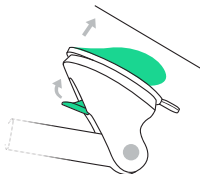

Additional Information
To reuse the suction cup, simply rinse under warm water and let air dry to restore tacky suction.

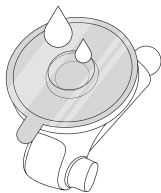

*Telescopic arm extends from 4 inches to 6 inches.

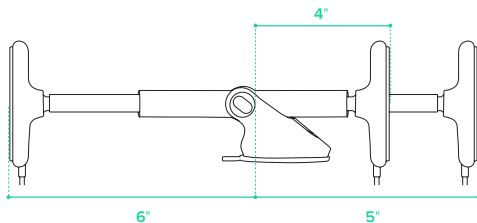

Connecting to Power

Connect the attached USB-C cable to the included 12V adapter and plug the adapter into your vehicle's auxiliary power outlet.

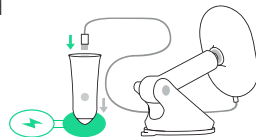

*The Velox Dash Mount does not have an on/off switch. Once the cable is plugged in and the vehicle is turned on, the mount will stay on.

Mounting Your Phone

Simply tap your phone against the mount and the magnets will hold it in place. Charging will begin automatically. You are now ready to start driving.

Indice

Pour une installation et un chargement optimaux, veuillez suivre les instructions détaillées de ce manuel lorsque vous utilisez le support de tableau de bord et de pare-brise de chargement magnétique sans fil Velox.

01 Informations du produit

Aperçu

Compatibilité de l'appareil

Caractéristiques du produit

02 Installation du support de tableau de bord Velox

Fixation du support de tableau de bord

Connexion à l'alimentation

Installation de votre téléphone

01 Informations du produit

Aperçu

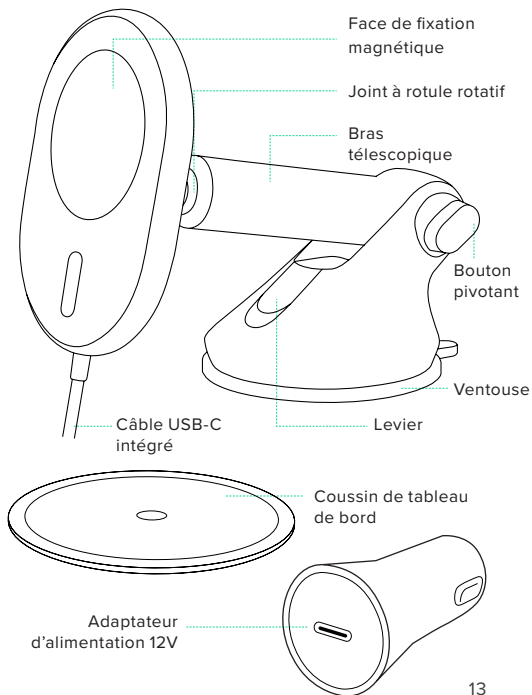

Compatibilité des appareils

Ces produits Velox est uniquement compatible avec les iPhones et les étuis de la série MagSafe. Les iPhones compatibles MagSafe comprennent les iPhone 13, iPhone 13 Mini, iPhone 13 Pro, iPhone 13 Pro Max, et la série iPhone 12.

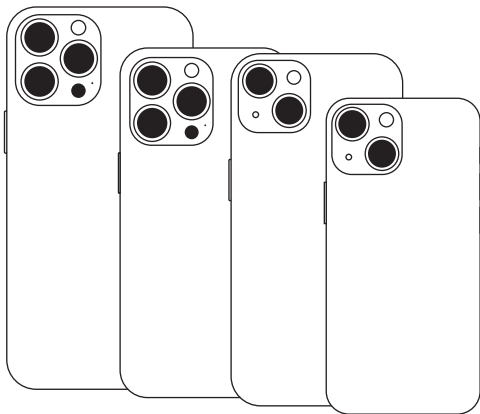

iPhone 13 Pro Max & 13 Pro

iPhone 13 & 13 Mini

*iOttie n'est pas responsable des dommages éventuels causés par une mauvaise utilisation du produit.

Caractéristiques du produit

Article	Caractéristique
Entrée totale	DC 9,0V-1,67A DC 5,0V-2,0A
Sortie du chargeur sans fil	7,5W
Longueur du câble	152,4 cm
Longueur du support	9,1 cm
Largeur	6,6 cm
Hauteur	11,94 cm
Poids	228.2 g

Caractéristiques du adaptateur d'alimentation

Entrée	Sortie
DC 12V ~ 24V	DC 5V ~ 3A DC 9V ~ 2A DC 12V ~ 1,5A

02 Installation du support de tableau de bord Velox

Fixation du support pour tableau de bord

Choisissez une méthode d'installation : tableau de bord/surface plane (A) ou pare-brise (B).

Option A

Installation sur tableau de bord ou surface plane

Choisissez une surface plane sur le tableau de bord du véhicule et essuyez toute poussière ou débris de la surface.

***Si votre véhicule est équipé d'un tableau de bord en cuir, nous vous recommandons une fixation au pare-brise pour éviter d'endommager votre tableau de bord.**

1. Décollez le film sur le coussin du tableau de bord et fixez-le à l'emplacement d'installation souhaité.

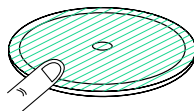

2. Décollez le film protecteur de la ventouse et appuyez fermement sur le pare-brise.

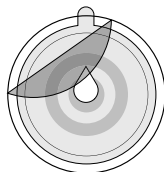

3. Abaissez le levier de verrouillage pour activer la ventouse.

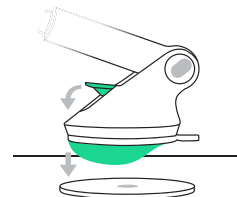

- Le coussin du tableau de bord est fixé d'un ruban adhésif semi-permanent. Une fois retiré, il ne peut pas être remonté.
- Lors du montage, il est recommandé que la surface et le produit soient au-dessus de 4°C.
- Lors du retrait du coussin du tableau de bord, veuillez faire preuve de prudence. Nous vous recommandons de retirer lentement du bord pour éviter tout dommage.

Option B

Installation au pare-brise

Choisissez un emplacement sur le pare-brise et essuyez toute poussière ou débris de la surface.

***Le coussin de tableau de bord n'est pas recommandé pour le montage sur pare-brise.**

1. Décollez le film protecteur de la ventouse et appuyez fermement sur le pare-brise.

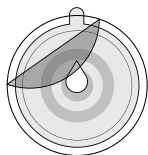

2. Abaissez le levier de verrouillage pour activer la ventouse.

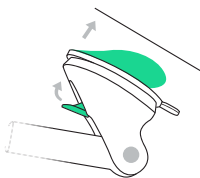

Informations supplémentaires

Pour réutiliser la ventouse, il suffit de la rincer à l'eau tiède et de la laisser sécher à l'air libre pour rétablir l'aspiration collante.

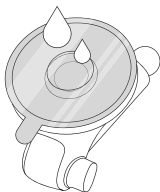

***Le bras télescopique s'étend de 10 centimètres à 15 centimètres.**

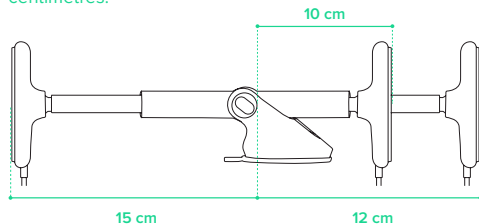

Connexion à l'alimentation

Connectez le câble USB-C fourni à l'adaptateur 12V inclus et branchez l'adaptateur dans la prise de courant auxiliaire de votre véhicule.

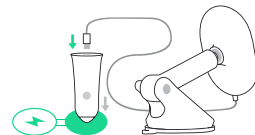

***Le support de tableau de bord Velox n'a pas l'interrupteur marche/arrêt. Une fois le câble branché et le véhicule allumé, le support restera allumé.**

Installation de votre téléphone

Tapez simplement votre téléphone contre le support et les aimants le maintiendront en place. La charge commencera automatiquement. Vous êtes maintenant prêt(e) à conduire.

Indice

Per una montatura e una ricarica ottimale, seguire le istruzioni dettagliate di questo manuale della Montatura Wireless Magnetica Velox per Parabrezza e Cruscotto.

01 Informazioni del prodotto

Sommario

Compatibilità del dispositivo

Specifiche del prodotto

02 Installazione Montatura Cruscotto Velox

Connessione Montatura Cruscotto

Collegamento all'alimentazione

Montatura del vostro telefono



01 Informazioni del prodotto

Sommario

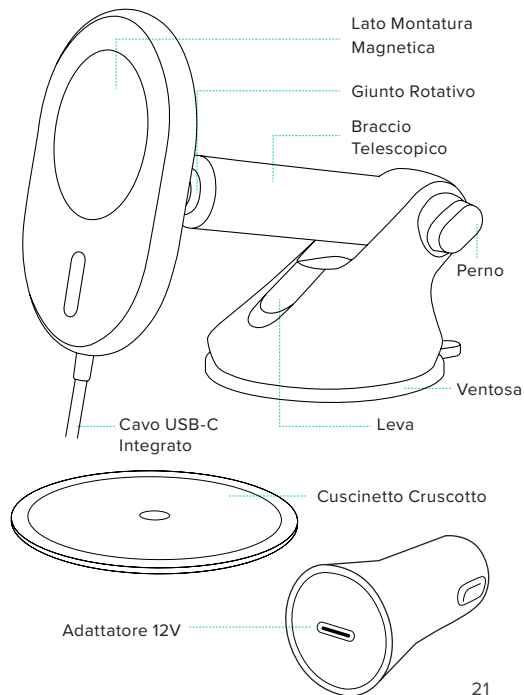

Compatibilità del dispositivo

I prodotti Velox sono compatibili solo con iPhone e le custodie della serie MagSafe. Gli iPhone compatibili con MagSafe includono l'iPhone 13, iPhone 13 Mini, iPhone 13 Pro, iPhone 13 Pro Max, e iPhone serie 12.

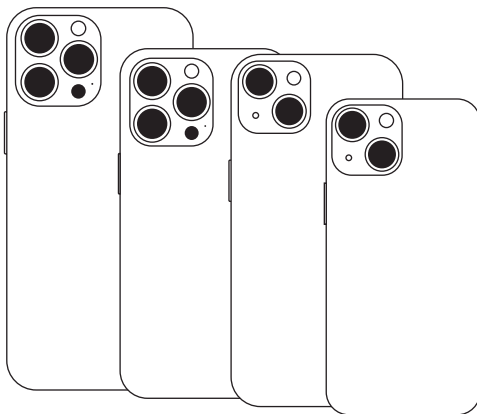

iPhone 13 Pro Max & 13 Pro

iPhone 13 & 13 Mini

*iOttie non è responsabile per eventuali danni causati da un uso improprio del prodotto.

Specifiche del prodotto

Descrizione	Specifiche
Input Totale	DC 9,0V-1,67A DC 5,0V-2,0A
Output Ricarica Wireless	7,5W
Lunghezza Cavo	152,4 cm
Lunghezza Montatura	9,1 cm
Larghezza	6,6 cm
Altezza	11,94 cm
Peso	228,2 g

Specifiche dell'adattatore

Input	Output
DC 12V ~ 24V	DC 5V ~ 3A DC 9V ~ 2A DC 12V ~ 1,5A

02 Installazione della Montatura Cruscotto Velox

Connessione Montatura Cruscotto

Scegliere un metodo di installazione: cruscotto/ superficie piatta (A) o parabrezza (B).

Opzione A

Installazione sul cruscotto o superficie piatta

Scegliere un'area piatta del cruscotto del veicolo e pulire polvere o detriti dalla superficie.

***Se il vostro veicolo ha un cruscotto in pelle, raccomandiamo l'installazione sul parabrezza per evitare danni.**

1. Rimuovere la pellicola del cuscinetto & connettere all'area di installazione.

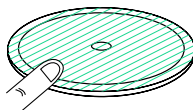

2. Rimuovere la pellicola protettiva della ventosa, e premere fermamente sul cuscinetto del cruscotto.

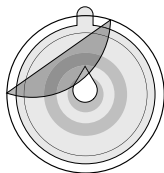

3. Abbassare la leva di sicurezza per assicurare la ventosa.

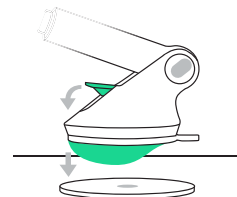

- Il cuscinetto del cruscotto è montato con adesivo semi-permanente. Una volta rimosso, non si può rimontare.
- Alla montatura, si consiglia di controllare che la superficie ed il prodotto siano sopra i 4°C.
- Si prega di fare attenzione quando si rimuove il cuscinetto del cruscotto. Si consiglia di rimuovere lentamente partendo dall'estremità per evitare danni.

Opzione B

Installazione sul parabrezza

Scegliere un'area del parabrezza e pulire polvere o detriti dalla superficie.

***Il cuscinetto del cruscotto non è raccomandato per montatura sul parabrezza.**

1. Rimuovi la pellicola protettiva della ventosa, e premere fermamente sul parabrezza.

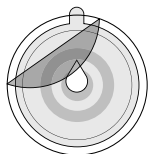

2. Abbassare la leva di sicurezza per assicurare la ventosa.

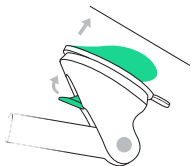

Ulteriori informazioni

Per riusare la ventosa, sciacquare sotto acqua tiepida e lasciare asciugare all'aria.



***Il braccio telescopico si estende da 10 centimetri a 15 centimetri.**

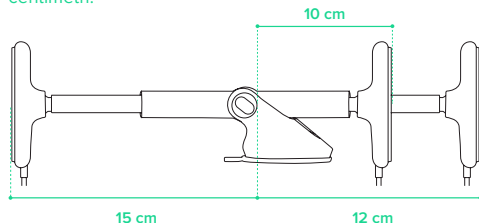

Collegamento all'alimentazione

Connettere il cavo USB-C all'adattatore incluso a 12V, e inserire l'adattatore alla presa ausiliaria della vostra macchina.

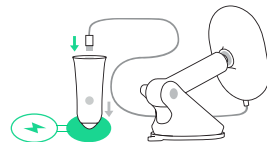

***La Montatura Cruscotto Velox non ha accensione/spengimento. Una volta che il cavo è collegato e il veicolo in moto, la montatura rimarrà fissata.**

Montatura del vostro telefono

Poggiare il vostro telefono contro la montatura e i magneti la manterranno assicurata. La ricarica partirà automaticamente. Siete ora pronti per la guida.

Index

Für eine optimale Montage und optimales Aufladen folgen Sie bei Verwendung der Velox magnetischen kabellosen Ladevorrichtung für Armaturenbrett und Windschutzscheibe bitte den detaillierten Anweisungen in dieser Anleitung.

01 Produktinformationen

Auf einen Blick

Kompatibilität der Geräte

Produktspezifikationen

02 Montage der Velox-Armaturenbrettbefestigung

Anbringen der Armaturenbrettbefestigung

Anschließen an die Stromversorgung

Befestigung Ihres Telefons

01 Produktinformationen

Auf einen Blick

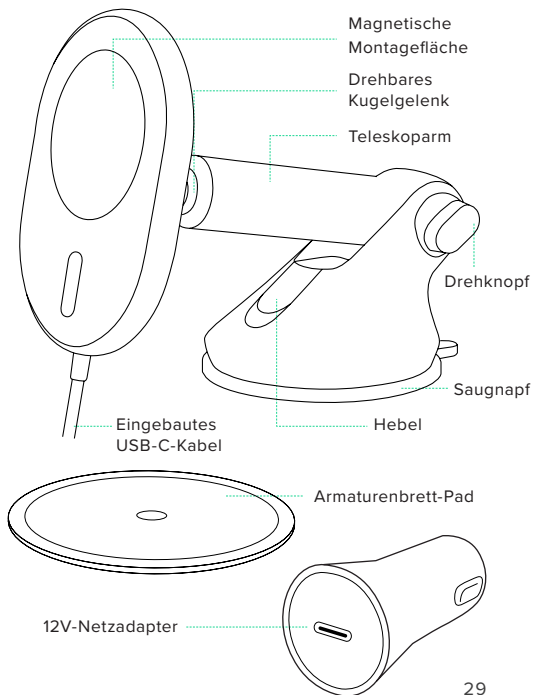

Gerätekompatibilität

Dieses Produkt ist ausschließlich mit iPhones und Hüllen der MagSafe-Serie kompatibel.

Zu den mit MagSafe kompatiblen iPhones gehören das iPhone 13, iPhone 13 Mini, iPhone 13 Pro, iPhone 13 Pro Max, und iPhone 12 serie.

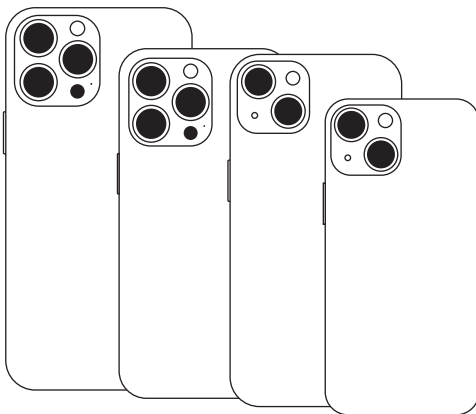

iPhone 13 Pro Max & 13 Pro

iPhone 13 & 13 Mini

*iOttie haftet nicht für mögliche Schäden, die auf Grund einer unsachgemäßen Verwendung des Produkts entstehen.

Produktspezifikationen

Daten	Spezifikation
Gesamteingang	Gleichstrom 9,0V-1,67A Gleichstrom 5,0V-2,0A
Ausgabe für kabelloses Aufladen	7,5W
Kabellänge	152,4 cm
Länge der Befestigung	9,1 cm
Breite	6,6 cm
Höhe	11,94 cm
Gewicht	228.2 g

Spezifikationen des Netzteils

Eingabe	Ausgabe
Gleichstrom 12V ~ 24V	Gleichstrom 5V ~ 3A Gleichstrom 9V ~ 2A Gleichstrom 12V ~ 1,5A

02 Montage der Velox-Armaturenbrettbefestigung

Anbringen der Armaturenbrettbefestigung

Wählen Sie eine Installationsmethode:

Armaturenbrett/glatte Oberfläche (A) oder
Windschutzscheibe (B).

Option A

Installation auf dem Armaturenbrett oder einer flachen Oberfläche

Wählen Sie eine flache Stelle auf dem Armaturenbrett des Fahrzeugs und entfernen Sie Staub und Schmutz von der Oberfläche.

***Wenn Ihr Fahrzeug ein ledernes Armaturenbrett hat, empfehlen wir die Montage an der Windschutzscheibe, um eine Beschädigung des Armaturenbretts zu vermeiden.**

1. Ziehen Sie die Folie vom Armaturenbrett-Pad ab und befestigen Sie sie an der gewünschten Einbaustelle.

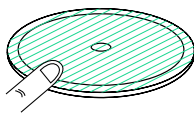

2. Ziehen Sie die Schutzfolie vom Saugnapf ab und drücken Sie ihn fest auf das Armaturenbrett-Pad.

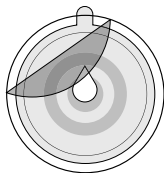

3. Drücken Sie den Verriegelungshebel nach unten, um die Ansaugung zu aktivieren.

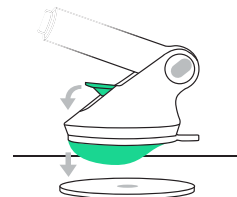

- Das Armaturenbrett-Pad wird mit einem semipermanenten Klebeband befestigt. Einmal entfernt, kann es nicht wieder angebracht werden.
- Bei der Montage wird empfohlen, dass die Oberfläche und das Produkt eine Temperatur von über 4°C haben.
- Gehen Sie beim Entfernen des Armaturenbrett-Pads bitte vorsichtig vor. Wir empfehlen, das Pad langsam von der Ecke aus zu entfernen, um Schäden zu vermeiden.

Option B

Einbau an der Windschutzscheibe

Wählen Sie eine Stelle auf der Windschutzscheibe und entfernen Sie Staub und Schmutz von der Oberfläche.

***Das Armaturenbrett-Pad wird nicht für die Montage an der Windschutzscheibe empfohlen.**

1. Ziehen Sie die Schutzfolie vom Saugnapf ab und drücken Sie ihn fest auf die Windschutzscheibe.
2. Drücken Sie den Verriegelungshebel nach unten, um die Ansaugung zu aktivieren.

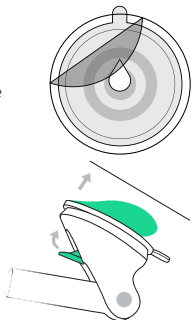

Zusätzliche Informationen

Um den Saugnapf wiederzuverwenden, spülen Sie ihn einfach unter warmem Wasser ab und lassen Sie ihn an der Luft trocknen, damit er wieder haftet.



***Der Teleskoparm reicht von 10 cm bis 15 cm.**

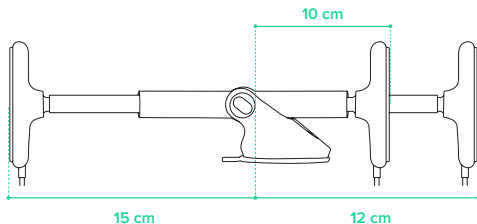

Anschließen an die Stromversorgung

Schließen Sie das beiliegende USB-C-Kabel an den mitgelieferten 12-V-Adapter an und stecken Sie den Adapter in die Hilfssteckdose Ihres Fahrzeugs.

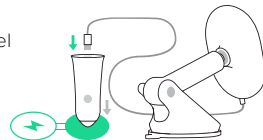

***Der Velox-Armaturenbrettbefestigung hat keinen Ein/Aus-Schalter. Sobald das Kabel eingesteckt ist und das Fahrzeug eingeschaltet wird, ist die Halterung eingeschaltet.**

Befestigung Ihres Telefons

Halten Sie Ihr Handy einfach an die Halterung, und die Magnete halten es an Ort und Stelle. Der Ladevorgang wird automatisch gestartet. Schon können Sie losfahren.

Índice

Para un montaje y carga óptima, siga las instrucciones detalladas en este manual al usar el soporte y cargador para tableros y parabrisas magnético Velox.

01 Información del producto

A simple vista

Compatibilidad de dispositivos

Especificaciones del producto

02 Instalación del Soporte para Tableros de Velox

Instalando el soporte para tableros y parabrisas

Conectar a la corriente

Montar su teléfono

01 Información del producto

A simple vista

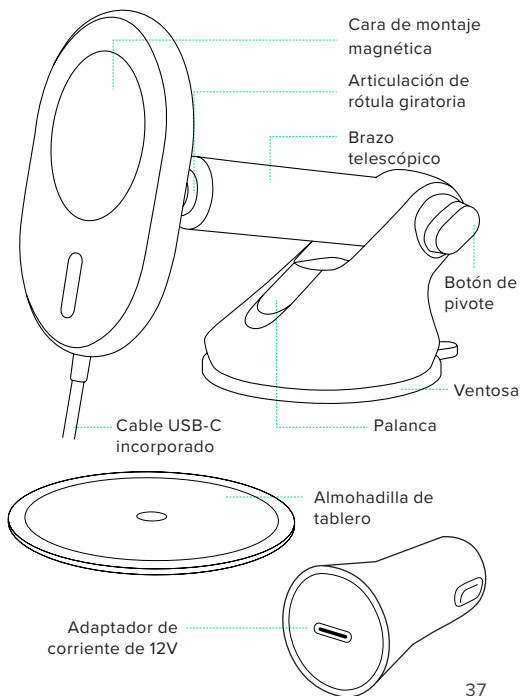

Compatibilidad de Dispositivos

Los productos Velox solo son compatible con iPhones y fundas de la serie MagSafe. Los iPhones compatibles con MagSafe incluyen iPhone 13, iPhone 13 Mini, iPhone 13 Pro, iPhone 13 Pro Max, y iPhone serie 12.

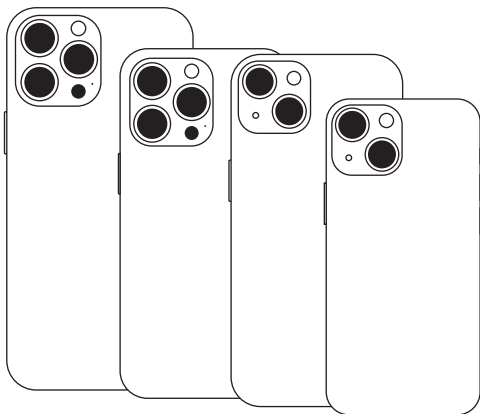

iPhone 13 Pro Max & 13 Pro

iPhone 13 & 13 Mini

*iOttie no es responsable por posibles daños debidos al uso incorrecto del producto.

Especificaciones del producto

Elemento	Especificación
Entrada Total	DC 9,0V-1,67A DC 5,0V-2,0A
Salida del cargador sin cables	7,5W
Longitud del cable	152,4 cm
Longitud de la montura	9,1 cm
Ancho	6,6 cm
Altura	11,94 cm
Peso	228,2 g

Especificaciones del adaptador de corriente

Entrada	Salida
DC 12V ~ 24V	DC 5V ~ 3A DC 9V ~ 2A DC 12V ~ 1,5A

02 Instalación del soporte y cargador magnético Velox

Instalando el soporte para tableros y parabrisas

Elija un locación de instalación: tablero/ superficie plana (A) o parabrisas (B).

Opción A

Instalación en el tablero o en una superficie plana

Elija una superficie plana en el tablero del vehículo y limpie el polvo o residuos que pueda haber en ella.

***Si su vehículo tiene un tablero de cuero, recomendamos el montaje en el parabrisas para evitar dañar al tablero.**

1. Retire la película en la almohadilla del tablero y fíjela en el lugar donde desea instalarla.

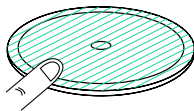

2. Retire la película protectora de la ventosa y presiónela firmemente sobre la almohadilla del tablero.

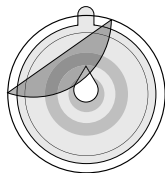

3. Presione la palanca de bloqueo para activar la succión.

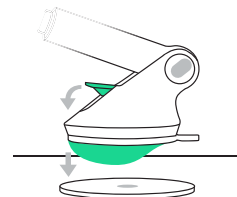

- La almohadilla del tablero está montada con una cinta adhesiva semipermanente. Una vez que es retirada, no puede montarse otra vez.
- Al hacer el montaje, se recomienda que la superficie y el producto tengan una temperatura superior a los 4°C.
- Tenga cuidado al retirar la almohadilla del tablero. Recomendamos retirarla lentamente desde el borde para evitar dañarla.

Opción B

Instalación en el parabrisas

Elija una ubicación en el parabrisas y limpie el polvo o residuos que puedan haber en su superficie.

***La almohadilla del tablero no se recomienda para el montaje en el parabrisas.**

1. Retire la película protector de ventosa y presiónela firmemente en el parabrisas.

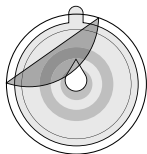

2. Presione la palanca de bloqueo para activar la succión.

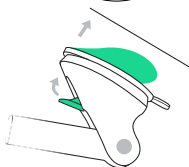

Información adicional

Para volver a usar la ventosa, simplemente enjuáguela con agua tibia y deje que se seque al aire para que recupere su succión pegajosa.



***El brazo telescópico va de 10 cm a 15 cm.**

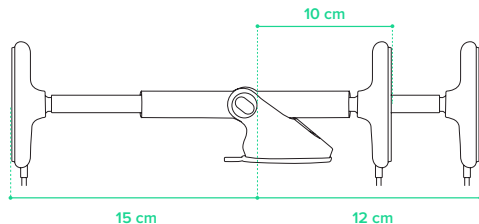

Conectar a la corriente eléctrica

Conecte el cable USB-C incorporado al adaptador de 12V incluido y enchufe el adaptador a la toma eléctrica auxiliar de su vehículo.

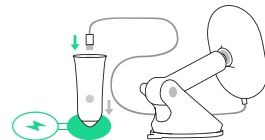

***El soporte para tableros de Velox no tiene un interruptor de encendido/apagado. Una vez que el cable esté enchufado y el se encienda el vehículo, la montura se mantendrá activada.**

Montar su teléfono

Simplemente toque la montura con su teléfono y los imanes lo mantendrán en su sitio. La carga comenzará de forma automática. Ya está listo para empezar a manejar.

Operation Warnings

NOTE: This equipment has been tested and found to comply with the limits for a Class B digital device, pursuant to part 15 of the FCC Rules. These limits are designed to provide reasonable protection against harmful interference in a residential installation. This equipment generates uses and can radiate radio frequency energy and, if not installed and used in accordance with the instructions, may cause harmful interference to radio communications. However, there is no guarantee that interference will not occur in a particular installation. If this equipment does cause harmful interference to radio or television reception, which can be determined by turning the equipment off and on, the user is encouraged to try to correct the interference by one or more of the following measures:

- Reorient or relocate the receiving antenna.
- Increase the separation between the equipment and receiver.
- Connect the equipment into an outlet on a circuit different from that to which the receiver is connected.
- Consult the dealer or an experienced radio/TV technician for help

Changes or modifications not expressly approved by the party responsible for compliance could void the user's authority to operate the equipment.

This device complies with Part 15 of the FCC Rules. Operation is subject to the following two conditions:

- (1) this device may not cause harmful interference, and (2) this device must accept any interference received, including interference that may cause undesired operation.

RF Exposure Warning Statements:

This equipment complies with FCC radiation exposure limits set

forth for an uncontrolled environment. This equipment shall be installed and operated with minimum distance 20cm between the radiator & body.

This device contains licence-exempt transmitter(s)/receiver(s) that comply with Innovation, Science and Economic Development Canada's licence-exempt RSS(s). Operation is subject to the following two conditions:

- (1) This device may not cause interference.
- (2) This device must accept any interference, including interference that may cause undesired operation of the device.

L'émetteur/récepteur exempt de licence contenu dans le présent appareil est conforme aux CNR d'Innovation, Sciences et Développement économique Canada applicables aux appareils radio exempts de licence. L'exploitation est autorisée aux deux conditions suivantes :

- (1) L' appareil ne doit pas produire de brouillage;
- (2) L' appareil doit accepter tout brouillage radioélectrique subi, même si le brouillage est susceptible d' en compromettre le fonctionnement.

Radio Frequency Exposure Statement for IC

This equipment complies with IC exposure limits set forth for an uncontrolled environment. This equipment shall be installed and operated with minimum distance 20cm between the radiator & body.

Cet équipement est conforme aux limites d'exposition IC définies pour un environnement non contrôlé. Cet équipement doit être installé et utilisé avec une distance minimale de 20cm entre le radiateur et la carrosserie.

Important Safety Information

This manual contains important safety and operating instructions for the Velox™ Magnetic Wireless Charging Dash & Windshield Mount (MGSFIO103).

Please read all instructions and safety information before using this product. If damage occurs as a result of failure to follow the instructions, the warranty will be voided.

- Do not expose to rain, moisture, or snow.
- Using an attachment made or sold by anyone other than the manufacturer is not recommended, doing so may result in an increased risk of fire, electric shock, or injury.
- Do not operate this magnetic wireless charging mount if it has received a sharp blow, been dropped, or otherwise damaged in any way; take it to a qualified service person.
- Do not disassemble this magnetic wireless charging mount; take it to a qualified service person when service or repair is required. Incorrect reassembly may result in electric shock or fire.
- To reduce the risk of electric shock, unplug this car charger before attempting any maintenance or cleaning. Turning off the vehicle controls will not reduce this risk.
- Avoid extended exposure to direct sunlight, which may damage the device.
- Exposing this product to open flames may cause it to explode.
- Do not expose this product to strong magnetic fields.
- Use a dry, soft lint-free cloth to clean. Do not use any corrosive cleaner or oil to clean.

*Always obey traffic laws and pay attention to the road. Do not attempt to use this device while driving.



This product complies with the radio interference requirements of the European Community.



This product is designed and manufactured with high quality materials and components, which can be recycled and reused.



The product must not be discarded as household waste, and should be delivered to an appropriate collection facility for recycling. Proper disposal and recycling helps protect natural resources, human health and the environment. For more information on disposal and recycling of this product, contact your local municipality, disposal service, or the shop you bought this product.

Designed in New York City. 20 W 37th St, New York, NY 10018.
Made in China. U.S. Patent Pending ©2021 iOttie. All rights reserved. iOttie and Velox are registered trademarks owned by iOttie, Inc. John 3:16

Apple, the Apple logo, iPhone, iPod, iPod touch, Mac, macOS, Magsafe and Siri are trademarks of Apple Inc., registered in the U.S. and other countries.



The Velox Magnetic Wireless Charging Dashboard & Windshield Mount is backed by a 2 year warranty.

iottie

MagSafe Compatible

Only compatible with MagSafe iPhone series and cases.